

USE AND CARE GUIDE

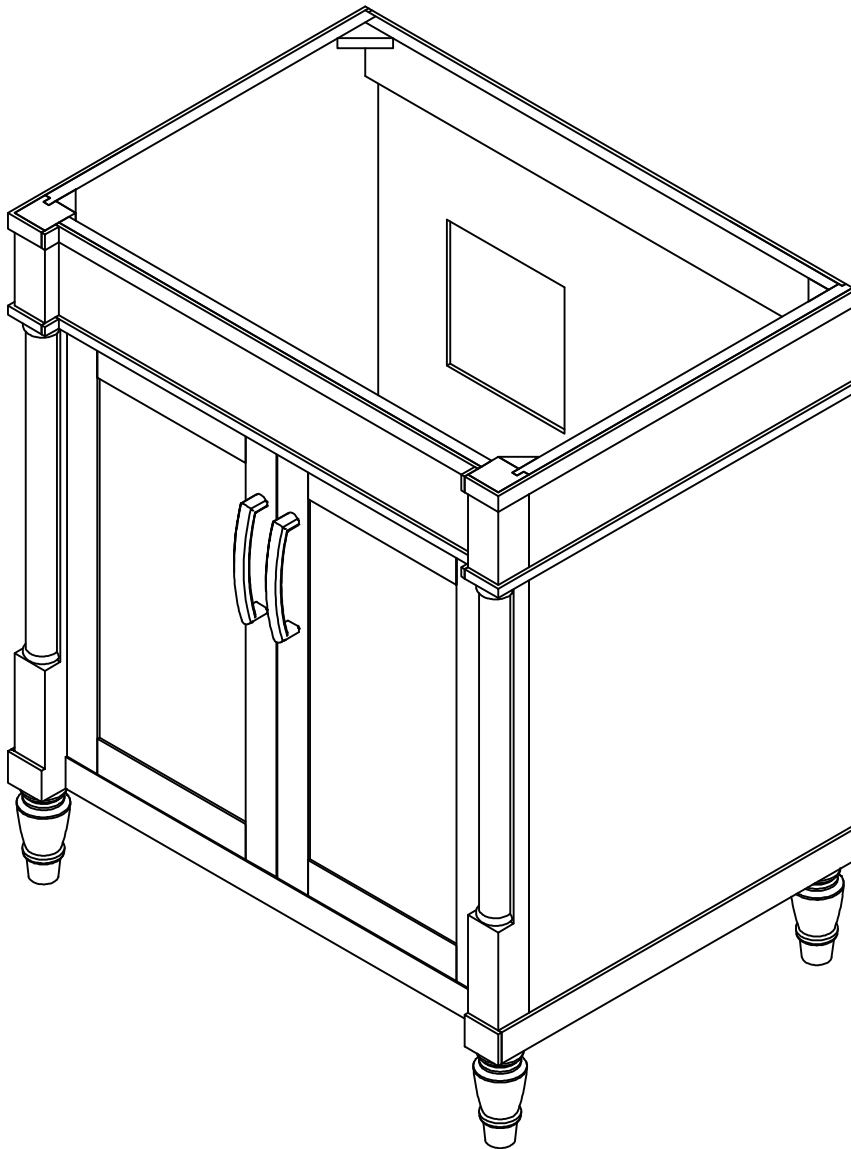

Before starting your installation, please take a few minutes to READ THESE INSTRUCTIONS CAREFULLY. In addition, please check the product CAREFULLY for any visible damage.

Model#: VH36VNGR



USE AND CARE GUIDE



Before starting your installation, please take a few minutes to READ THESE INSTRUCTIONS CAREFULLY. In addition, please check the product CAREFULLY for any visible damage.

Model#: VH36VNGR

PRE-ASSEMBLY VANITY BODY

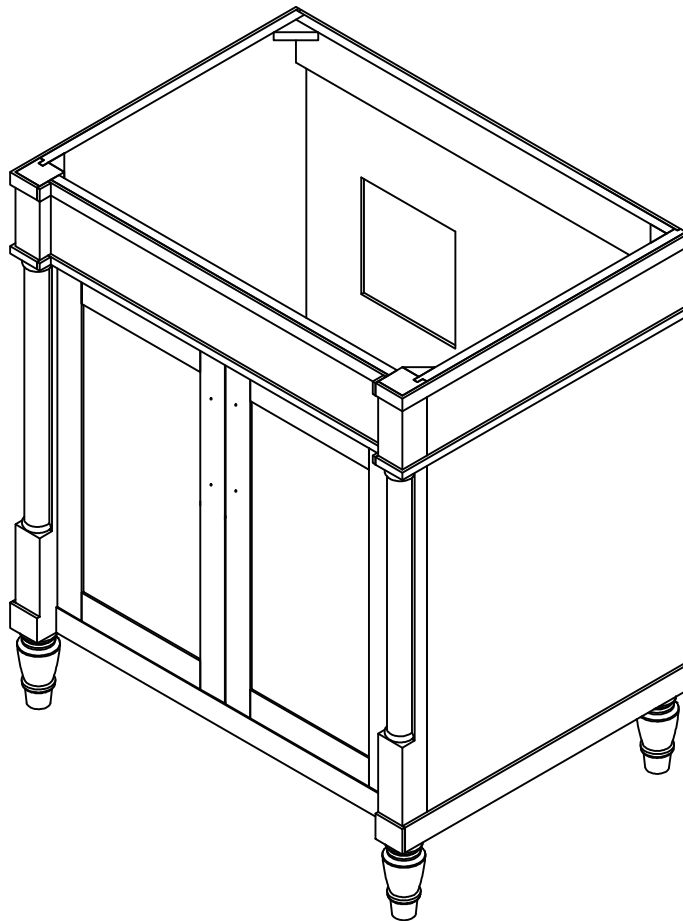

Part	Description	Quantity
A	Vanity body	1

USE AND CARE GUIDE



Before starting your installation, please take a few minutes to READ THESE INSTRUCTIONS CAREFULLY. In addition, please check the product CAREFULLY for any visible damage.

Model#: VH36VNGR

TOOLS REQUIRED



NOTE: Tools shown are not included.



Phillips
screwdriver

HARDWARE INCLUDED



NOTE: Hardware not shown to actual size.



AA x 4



BB x 2

Part	Description	Quantity
AA	Handle screws	4
BB	Door handle	2

USE AND CARE GUIDE



Before starting your installation, please take a few minutes to READ THESE INSTRUCTIONS CAREFULLY. In addition, please check the product CAREFULLY for any visible damage.

Model#: VH36VNGR

- 1** Decide exactly where you wish to install your vanity and gently put it down on the floor.

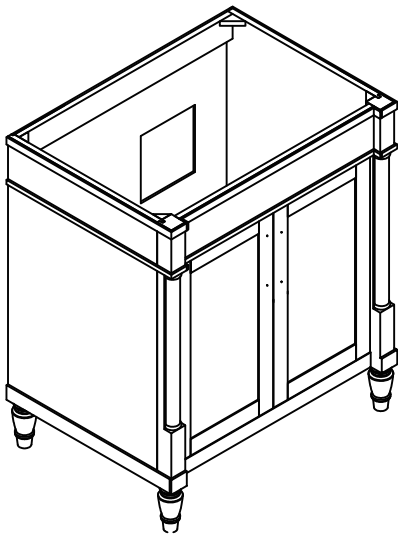

- 2** Remove all the handles (BB) from the back of door.

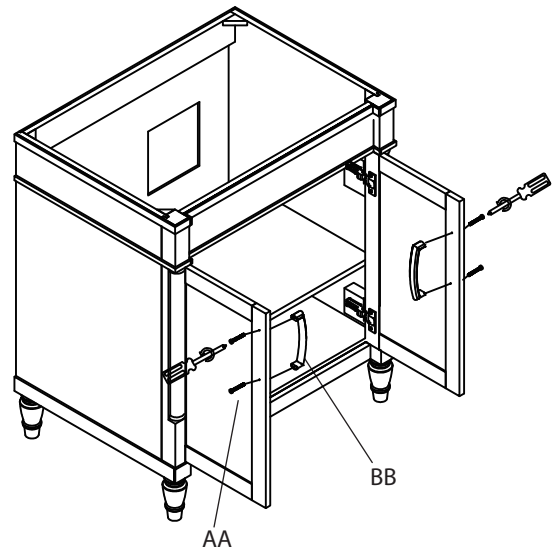

- 3** Install the handle on front of the door.

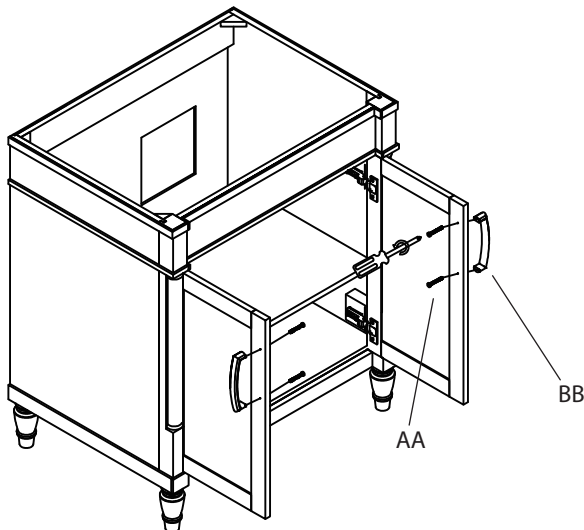

- 4** Install the counter top according to counter top instruction manual.

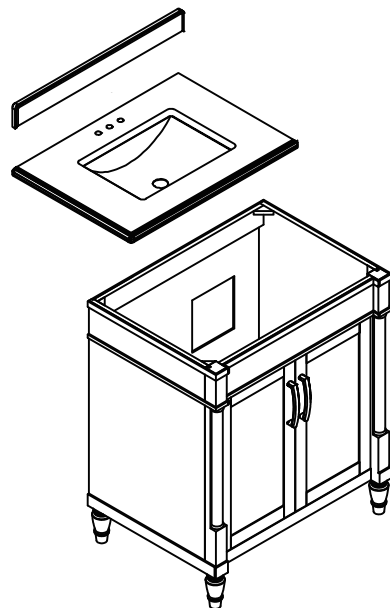

USE AND CARE GUIDE



Before starting your installation, please take a few minutes to READ THESE INSTRUCTIONS CAREFULLY. In addition, please check the product CAREFULLY for any visible damage.

Model#: VH36VNGR

CARE AND MAINTENANCE

For best results in cleaning and polishing your bath furniture, we recommend the following:

- Dust frequently with a clean, soft, dry, lint-free cloth. Clean the surface by rubbing in the direction of the grain.
- Polish your furniture approximately every six months with a product that contains detergents, emulsifiers and mineral oil. The detergents clean dirt from the furniture; The emulsifiers give it body to clean and last longer; The mineral oil is left behind as barrier for dirt and moisture that can harm the finish. There is no grit to harm the finish, no wax build-up, and no silicone to raise the sheen and act as a barrier for touch-ups and refinishing.
- Clean the outside surface with mild soap, warm water, and a soft cloth.
- On stubborn stains, use a powdered detergent and damp sponge or nylon scouring pad.
- Never use abrasive scouring powders, cleansers, or pads because they will scratch, damage, and dull the surface.

To protect your bath furniture, we suggest the following:

- Avoid placing your furniture in direct sunlight, as sunlight causes fading.
Clean up spills immediately. Use a blotting rather than a wiping action. Water left over a long period of time will cause white spots in the finish.
- Alcohol, perfume, aftershave and medications can cause severe finish damage.